

VERSIONE IN MARCIA

VERSIONE GIORNO

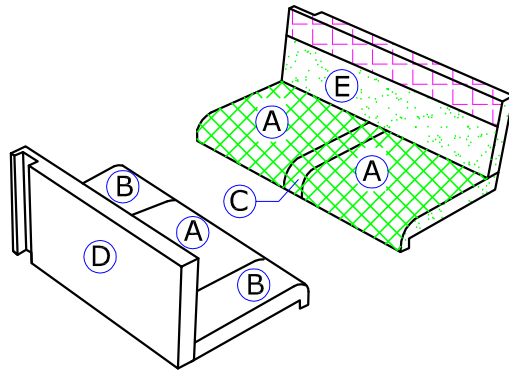

LEGENDA	
TIPO	TESSUTO
	Vermentino col.01 trapuntato
	Vermentino col.01 liscio
	Ornellaia rosso col.10
	Ornellaia marrone col.622

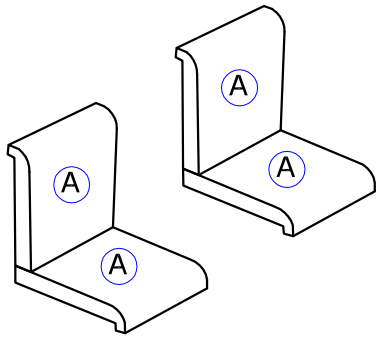
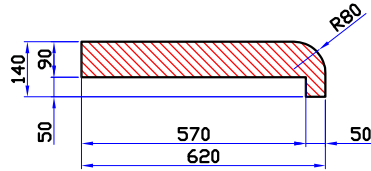
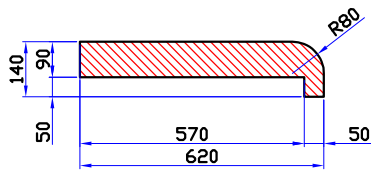

Vestitino per spalliera struttura cinture

Q.ta n°2

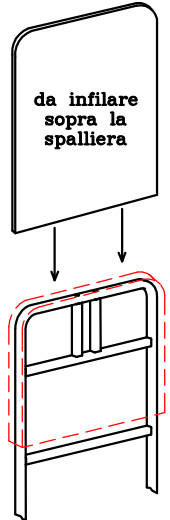

Q.ta n°4

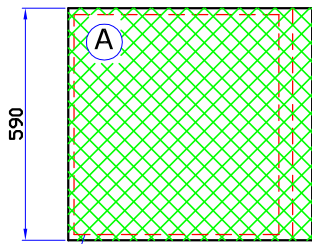

Inserire tavola

Q.ta n°2

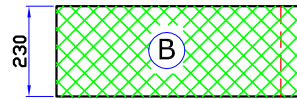

Q.ta n°1

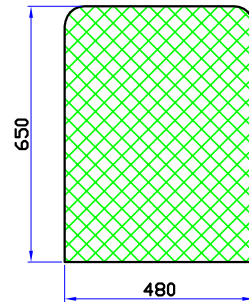

20

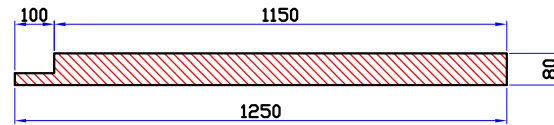
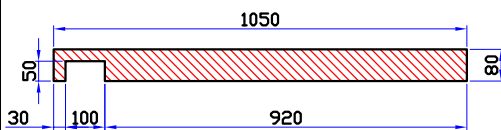

Q.ta n°2

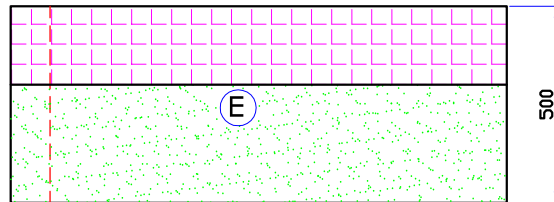
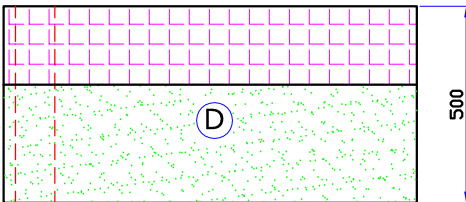
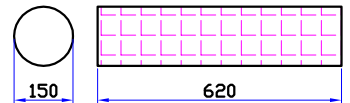

Q.ta n°2

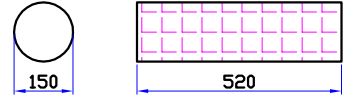

COPRICOLONNNA Q.ta n° 2

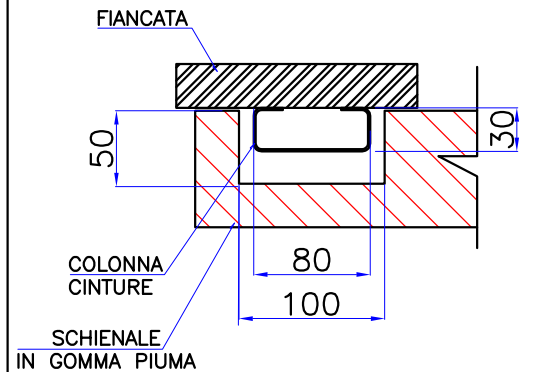
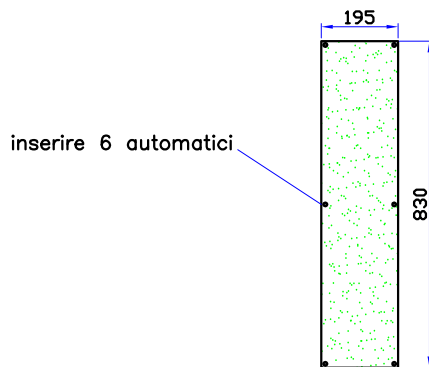

LCAMP **Kentucky camp** **XGO**
SEDE Via Piemonte n°3
53036 Poggibonsi SIENA ITALY

Denominazione
Cuscini Seal 66

Codice
1TAP090622

Caratteristiche gommapiuma
SCHIENALI-POGGIATESTA Densita'21 Kg/m³
SEDUTE-MATERASSI Densita'25 Kg/m³

Codice lavorazione

TOLLERANZE DI MASSIMA
Grado di precisione medio
UNI 5307

PAG 1 di 1

Produzione 2018-2019 Meccanica FIAT NOTE Le dimensioni sono riferite al cuscino finito

Rev 02 Data 04-02-2019

Disegnato A.PINZUTI Data 11-12-2018

02 Allargato vestitino spalliera panchina cinture

04-02-2019 A.PINZUTI

Approvato A.PINZUTI Data 11-12-2018

01 Rimosso lombare dalla seduta

23-11-2018 M.Crescenza

Rev MODIFICA

DATA ESEGUITA

I dati e le informazioni contenuti o ricavabili da questo disegno sono di esclusiva proprieta' della Luano Camp S.r.l. Ogni riproduzione totale o parziale e' vietata senza l'autorizzazione scritta della ditta Luano Camp S.r.l.